



HAL
open science

H-infinity Takagi-Sugeno fuzzy control of a lower limbs rehabilitation device

Lynda Seddiki, Kevin Guelton, Badr Mansouri, J. Zaytoon

► **To cite this version:**

Lynda Seddiki, Kevin Guelton, Badr Mansouri, J. Zaytoon. H-infinity Takagi-Sugeno fuzzy control of a lower limbs rehabilitation device. 2006 IEEE Conference on Computer Aided Control System Design, 2006 IEEE International Conference on Control Applications, 2006 IEEE International Symposium on Intelligent Control, Oct 2006, Munich, France. <10.1109/CACSD-CCA-ISIC.2006.4776769>. <hal-01736808>

HAL Id: hal-01736808

<https://univ-reims.hal.science/hal-01736808v1>

Submitted on 22 Aug 2024

HAL is a multi-disciplinary open access archive for the deposit and dissemination of scientific research documents, whether they are published or not. The documents may come from teaching and research institutions in France or abroad, or from public or private research centers.

L'archive ouverte pluridisciplinaire **HAL**, est destinée au dépôt et à la diffusion de documents scientifiques de niveau recherche, publiés ou non, émanant des établissements d'enseignement et de recherche français ou étrangers, des laboratoires publics ou privés.



HAL Authorization

H-infinity Takagi-Sugeno fuzzy control of a lower limbs rehabilitation device

L. Seddiki, *Student Member, IEEE*, K. Guelton, B. Mansouri and J. Zaytoon

Abstract—This paper deals with the nonlinear control of a lower limbs isokinetic rehabilitation device based on a Takagi-Sugeno modeling. A Parallel Distributed Compensation control law is used to stabilize the closed-loop system in the whole operational space. The human force applied to the device's arm is considered as an external disturbance to the system dynamics. To attenuate this disturbance, an H_∞ criterion is considered and classical stability conditions were adapted for a class of external perturbed TS model. The voluntary control of the movement by the patient is finally proposed with the use of a discrete state machine.

I. INTRODUCTION

ISOKINETICS devices are widely used in the field of knee rehabilitation. This kind of apparatus often solicits knee joints in the sagittal plane with one degree of freedom. Previous works in our research center led to the realization of the Multi-ISO rehabilitation device presented in fig. 1 [1]. To obtain a good tracking behavior and to achieve the clinical goals defined for Multi-ISO [2], three control laws have been proposed. The first and the second control laws, based on proportional integral correctors, are used to control the angular position and the angular velocity of the rehabilitation device. A force controller allows realizing the same behavior as a weighted mechanical apparatus. Although the results obtained with these controllers are satisfying in terms of rehabilitation specifications, they are restrictive in terms of control performance, mainly because they do not theoretically guarantee a good behavior in all the state space and they do not ensure the rejection of external disturbances such as the patient force.

The dynamics model of the rehabilitation device is presented in the next section. The aim of this paper is to propose a nonlinear controller that is adapted to the nonlinear model of the rehabilitation device and ensures the stability in the whole operational space while attenuating external disturbances. In order to comply with the desired control specifications, a fuzzy Takagi-Sugeno (TS) model is presented in section 3, together with a Parallel Distributed Compensation (PDC) control law [3]. The synthesis of the control law is presented in the section 4 and a H_∞ criterion is employed to guarantee the attenuation of human

uncontrolled disturbance. Theoretical stability conditions, based on the works of [4] are given in term of Linear Matrix Inequalities (LMI) for the considered class of perturbed nonlinear systems. In section 5, simulation results illustrate the efficiency of the nonlinear control law and, in the last section, a state machine is proposed to specify the human voluntary control of the rehabilitation device.

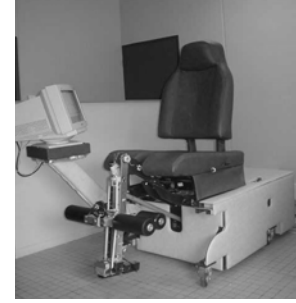

Fig 1. Multi-ISO lower limbs rehabilitation device

II. DYNAMICAL MODELING OF MULTI-ISO

Fig. 2 shows the mechanical scheme of Multi-ISO that consists in applying a torque produced by a synchronous motor to the lower limbs of the patient. This motorization can reach a nominal force of 200 daN applied by the patient at the end of the device's arm and a speed of $2\pi\text{ rad}\cdot\text{s}^{-1}$ under maximal load [2]. The Multi-ISO model, derived using Lagrange method, is given by:

$$\begin{aligned} J_m \ddot{\theta}(t) + (f_m - k|\dot{\theta}(t)|)\dot{\theta}(t) \\ - M_1 \cos \theta(t) - M_2 \sin \theta(t) = \Gamma_m(t) + L.f_p(t) \end{aligned} \quad (1)$$

Where Γ_m is the input torque, f_p is the force applied by the patient on the device arm, θ is the angular position with respect to horizontal and the other parameters are described in table 1.

Let us consider the following generic state space representation of a nonlinear perturbed model:

$$\begin{cases} \dot{x}(t) = A(x(t))x(t) + B(x(t))u(t) + \phi(t) \\ y(t) = C(x(t))x(t) \end{cases} \quad (2)$$

This work was supported by the French Ministry of research and the "Région Champagne-Ardennes" within the framework of the CPER SYS-REEDUC.

The authors are with the CReSTIC-URCA, Moulin de la House BP 1039, F-51687 Reims Cedex 2, France.

Corresponding author: Kevin Guelton, phone: +33-3-26-91-83-86; fax: +33-3-26-91-31-06; e-mail: kevin.guelton@univ-reims.fr.

where, $x(t)$ is the state vector, $u(t)$ and $y(t)$ are respectively the inputs and the outputs vector. $A(x(t))$, $B(x(t))$, $C(x(t))$ are the non-constant nonlinear model matrices and $\phi(t)$ the vector of external perturbation.

In the considered application, $x(t) = [\dot{\theta}(t) \ \theta(t)]^T$ and the dynamical model (1) can be written as a nonlinear perturbed model (2) with a nonlinear matrix $A(x(t))$ and constant matrices B, C . These matrices are given by:

$$A(x(t)) = \begin{bmatrix} k|\dot{\theta}| - f_m & M_1 \cos \theta + M_2 \sin \theta \\ J_m & J_m \theta \\ 1 & 0 \end{bmatrix},$$

$$B = [1/J_m \ 0], \quad C = [0 \ 1],$$

The vector $\phi(t) = Hf_p(t)$, where $H = [L/J_m \ 0]^T$ is constant, is considered as an external disturbance to the dynamical rehabilitation device model without human load.

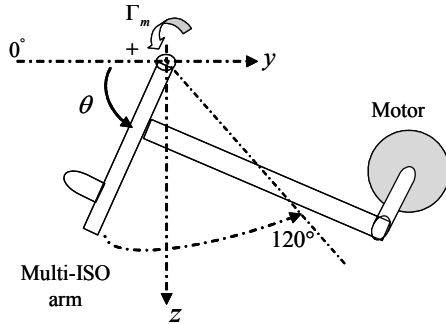

Fig. 2. The rehabilitation device principle.

TABLE I
NUMERICAL PARAMETERS OF THE DYNAMICAL MODEL OF THE REHABILITATION DEVICE MULTI-ISO

Param.	Designation	Value	Unit
J_m	Arm inertia	33.8	kgm^2
f_m	Viscous friction	103.6	$N(rad/s)^{-1}$
M_1	Gravitational coefficient	110	N
M_2	Gravitational coefficient	31	N
L	Arm's length	0.5	m
k	Coriolis coefficient	70	$Nm(rad/s)^{-1}$

III. TS FUZZY MODELING OF MULTI-ISO

Let us consider the generic state space representation of a nonlinear perturbed model (2). A fuzzy Takagi-Sugeno representative leads to a set of r linear time invariant (LTI) models that are interpolated with nonlinear functions [5]:

$$\begin{cases} \dot{x}(t) = \sum_{i=1}^r h_i(z(t))(A_i x(t) + B_i u(t) + H_i \phi(t)) \\ y(t) = \sum_{k=1}^r h_k(z(t)) C_k x(t) \end{cases} \quad (3)$$

where H_i are the local transfer matrices of the external disturbance vector $\phi(t)$ to the state vector:

$$\phi(t) = \sum_{i=1}^r h_i H_i \phi(t)$$

The functions $h_i(z(t))$, $i \in \{1, \dots, r\}$, are assumed to be positive, to use only measured variables $z(t)$ and to satisfy the convex sum property, i.e. $\sum_{i=1}^r h_i(z) = 1$.

In the following, for notation simplifications, we will use the notation $\alpha(x) \in [\underline{\alpha} \ \bar{\alpha}]$ with $\underline{\alpha} = \min_x \alpha(x)$ and $\bar{\alpha} = \max_x \alpha(x)$.

The dynamical model of Multi-ISO (1) can be written in a TS form considering the following nonlinear functions involved in $A(x(t))$:

$$\begin{aligned} \eta_1(x(t)) &= \frac{k|\dot{\theta}| - f_m}{J_m} \in [\underline{\eta}_1 \ \bar{\eta}_1] \\ \eta_2(x(t)) &= M_1 \frac{\cos \theta}{J_m \theta} + M_2 \frac{\sin \theta}{J_m \theta} \in [\underline{\eta}_2 \ \bar{\eta}_2] \end{aligned} \quad (4)$$

A TS representative model is obtained by splitting the nonlinear function as follows [6]:

$$f(x(t)) = \underbrace{\frac{\bar{f} - f(x(t))}{\bar{f} - \underline{f}}}_{\omega_f^1(x(t))} \cdot \underline{f} + \underbrace{\frac{f(x(t)) - \underline{f}}{\bar{f} - \underline{f}}}_{\omega_f^2(x(t))} \cdot \bar{f} \quad (5)$$

with $f \in \{\eta_1, \eta_2\}$ and:

$$\omega_f^1(x(t)) = \frac{\bar{f} - f(x(t))}{\bar{f} - \underline{f}} = 1 - \omega_f^2(x(t)) \quad (6)$$

Note that, using this method, the number of rules r is determined by the number q of the nonlinear function to be splitted. Thus, $r = 2^q$ and, considering the functions ω_f^1 and ω_f^2 for $f = \{\eta_1, \eta_2\}$, the TS modeling leads to the following 4 fuzzy rules:

$$\begin{aligned}
R_1: \quad & \underline{\text{IF}} \ \eta_1(x(t)) \text{ is } \omega_{\eta_1}^1 \text{ AND } \eta_2(x(t)) \text{ is } \omega_{\eta_2}^1 \\
& \underline{\text{THEN}} \ \begin{cases} \dot{x}(t) = A_1x(t) + Bu(t) + Hf_p(t) \\ y(t) = Cx(t) \end{cases} \\
R_2: \quad & \underline{\text{IF}} \ \eta_1(x(t)) \text{ is } \omega_{\eta_1}^1 \text{ AND } \eta_2(x(t)) \text{ is } \omega_{\eta_2}^2 \\
& \underline{\text{THEN}} \ \begin{cases} \dot{x}(t) = A_2x(t) + Bu(t) + Hf_p(t) \\ y(t) = Cx(t) \end{cases} \\
R_3: \quad & \underline{\text{IF}} \ \eta_1(x(t)) \text{ is } \omega_{\eta_1}^2 \text{ AND } \eta_2(x(t)) \text{ is } \omega_{\eta_2}^1 \\
& \underline{\text{THEN}} \ \begin{cases} \dot{x}(t) = A_3x(t) + Bu(t) + Hf_p(t) \\ y(t) = Cx(t) \end{cases} \\
R_4: \quad & \underline{\text{IF}} \ \eta_1(x(t)) \text{ is } \omega_{\eta_1}^2 \text{ AND } \eta_2(x(t)) \text{ is } \omega_{\eta_2}^2 \\
& \underline{\text{THEN}} \ \begin{cases} \dot{x}(t) = A_4x(t) + Bu(t) + Hf_p(t) \\ y(t) = Cx(t) \end{cases}
\end{aligned}$$

From (5), (6) and the 4 fuzzy rules, we obtain the simplified fuzzy TS model of the Multi-ISO device:

$$\begin{cases} \dot{x}(t) = \sum_{i=1}^4 h_i(z(t)) A_i x(t) + Bu(t) + Hf_p(t) \\ y(t) = Cx(t) \end{cases} \quad (7)$$

$$\text{with } \begin{cases} h_1(x(t)) = \omega_{\eta_1}^1 \omega_{\eta_2}^1 \\ h_2(x(t)) = \omega_{\eta_1}^1 \omega_{\eta_2}^2 \\ h_3(x(t)) = \omega_{\eta_1}^2 \omega_{\eta_2}^1 \\ h_4(x(t)) = \omega_{\eta_1}^2 \omega_{\eta_2}^2 \end{cases} \text{ and } \begin{cases} A_1 = \begin{bmatrix} \bar{f}_1 & \bar{f}_2 \\ 1 & 0 \end{bmatrix}, A_2 = \begin{bmatrix} \bar{f}_1 & \bar{f}_2 \\ 1 & 0 \end{bmatrix}, \\ A_3 = \begin{bmatrix} \underline{f}_1 & \underline{f}_2 \\ 1 & 0 \end{bmatrix}, A_4 = \begin{bmatrix} \underline{f}_1 & \underline{f}_2 \\ 1 & 0 \end{bmatrix}. \end{cases}$$

Note that $\eta_2(x(t))$ is singular on $\theta = 0$. Therefore, for a convenient control and with respect to the required movement for a rehabilitation use, the operational state space is reduced to the compact space bounded by $\theta \in [\pi/180 \ 2\pi/3]$ (rad). Moreover, according to technical capabilities of Multi-ISO, the velocity is bounded by $\dot{\theta} \in [-2\pi \ 2\pi]$ (rad \cdot s⁻¹).

IV. H_∞ FUZZY CONTROL DESIGN

Since the Multi-ISO TS fuzzy model is a particular case, with B_i and H_i commons, of the class of external perturbed TS model (2), generic stability conditions for this class of nonlinear systems are proposed in this section. Let us consider the following generic external perturbed TS model:

$$\dot{x}(t) = \sum_{i=1}^r h_i(z(t)) [A_i x(t) + B_i u(t) + H_i \varphi(t)] \quad (8)$$

The Parallel Distributed Compensation (PDC) control law is defined as [3]-[7]-[8]:

$$u(t) = -\sum_{i=1}^r h_i(z(t)) K_i x(t) \quad (9)$$

The close loop system can be written as:

$$\dot{x}(t) = \sum_{i=1}^r \sum_{j=1}^r h_i(z(t)) h_j(z(t)) [(A_i - B_i K_j) x(t) + H_i \varphi(t)] \quad (10)$$

The goal is now to find the gain matrices K_j that ensure the stability of system (10) and attenuate the external disturbance $\varphi(t)$. This can be achieved using the following H_∞ criterion:

$$\int_0^{\theta_f} (x(t)^T Q x(t)) dt \leq \eta^2 \int_0^{\theta_f} (\varphi(t)^T \varphi(t)) dt \quad (11)$$

with $Q > 0$

Previous works have given the stability conditions for a class of external perturbed TS model that considers a common disturbance vector $\phi(t)$ [4]. In the following we adapt these conditions to the class of external perturbed TS model (8) where the external disturbance can be splitted for each LTI model, i.e. $\phi(t) = \sum_{i=1}^r h_i H_i \varphi(t)$. The following theorem ensures the stability of the system (10) with respect to the criterion (11).

Theorem 1: The closed-loop fuzzy system (10) is quadratically stable if there exists $P = P^T > 0$, a positive constant η and feedback gains K_i that satisfy the following conditions:

$$\Upsilon_{ii} + \eta^{-1} P H_i H_i^T P + Q < 0, \quad i = 1, 2, \dots, r \quad (12)$$

$$\Upsilon_{ij} + \Upsilon_{ji} + \eta^{-1} P (H_i H_j^T + H_j H_i^T) P + 2Q < 0, \quad i < j \quad (13)$$

$$\text{with: } \Upsilon_{ij} = (A_i - B_i K_j)^T P + P (A_i - B_i K_j)$$

The solutions of this theorem are not LMI [9]-[10]. Consequently, numerical solutions are difficult to obtain with classical convex optimization algorithms [11]-[12]. In order to obtain LMI conditions, some matrix transformations are necessary [8]. Then, after congruence with $N = P^{-1}$ and using the convenient bijective change of variable $Y_i = K_i N_i$, (12) and (13) become respectively:

$$\begin{aligned}
& A_i N + N^T A_i^T - B_i Y - Y B_i^T \\
& + \frac{1}{\eta^2} H_i H_i^T + N Q N < 0 \quad \text{for } i = 1, \dots, r \quad (14)
\end{aligned}$$

$$\begin{aligned}
& A_i N + N^T A_i^T + A_j N + N^T A_j^T && \text{for } i < j \\
& -B_i Y_j - Y_j^T B_i^T - B_j Y_i - Y_i^T B_j^T && (15) \\
& + \frac{1}{\eta^2} (H_i H_j^T + H_j H_i^T) + 2NQN < 0
\end{aligned}$$

The application of the Schur complements on (14) and (15) leads to the following theorem with LMI conditions.

Theorem 2: The closed-loop fuzzy system (10) is quadratically stable if there exists $N = N^T > 0$, Y_i and a positive constant η that satisfy the following conditions:

$$\begin{aligned}
& \text{for } i = 1, 2, \dots, r \\
& \begin{bmatrix} \psi_i & N \\ N & -Q^{-1} \end{bmatrix} < 0 \\
& \text{with } \psi_i = A_i N + N^T A_i^T \dots \\
& -B_i Y_j - Y_j^T B_i^T + \frac{1}{\eta^2} H_i H_i^T
\end{aligned} \quad (16)$$

$$\begin{aligned}
& \text{for } i < j \\
& \begin{bmatrix} \Omega_{ij} & N \\ N & -\frac{1}{2}Q^{-1} \end{bmatrix} < 0 \\
& \text{with } \Omega_{ij} = A_i N + N^T A_i^T + A_j N + N^T A_j^T \dots \\
& -B_i Y_j - Y_j^T B_i^T - B_j Y_i - Y_i^T B_j^T \dots \\
& + \frac{1}{\eta^2} (H_i H_j^T + H_j H_i^T)
\end{aligned} \quad (17)$$

Note that these conditions are generic to the class of nonlinear systems (8). In the considered application, B_i , C_i and H_i are common matrices that subsequently simplify the computing of the LMI algorithms.

V. SIMULATION RESULTS

Let us consider the control scheme proposed in fig. 3 where $y_d(t)$ is the desired trajectory, $y(t) = \theta(t)$ is the output, i.e. Multi-ISO's arm angular position, $u(t) = \Gamma_m$ is the input torque and f_p is the force applied by the subject to Multi-ISO's arm.

The inverse tracking matrix allows us to specify as input to the global closed-loop system a desired trajectory $y_d(t)$ that is homogeneous to the output $y(t)$. This matrix is adapted from classical linear control theory [13] to TS multi-model control using the same membership functions $h_i(t)$ structure as the PDC control law:

$$T_{inv} = \left(C \left(\sum_{i=1}^4 h_i(z(t)) (BK_i - A_i) \right)^{-1} B \right)^{-1} \quad (18)$$

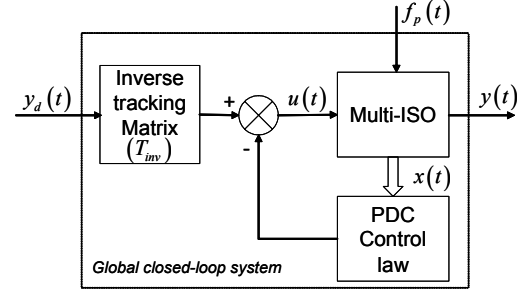

Fig. 3. Global Multi-ISO closed loop trajectory tracking control scheme.

The first simulation goal is to show that the closed-loop system is stable, i.e. $y(t)$ returns to a given position $y_d = \alpha$ from any position $y(t_0) \neq \alpha$. To achieve this goal, the gain matrices K_i are computed from theorem 2 using the MATLAB® LMI Toolbox [11]. We set the system dynamics goal matrix $Q = \text{diag}[1350 \ 1300]$ and the attenuation rate $\eta = 0.5$ to obtain a good dynamical behavior of the closed-loop system and to avoid oscillatory modes. Theorem 2 gives the following solution for the gain matrices that stabilize the TS fuzzy model of Multi-ISO:

$$\begin{aligned}
K_1 &= \begin{bmatrix} 12690 \\ 106820 \end{bmatrix}, & K_2 &= \begin{bmatrix} 12690 \\ 100480 \end{bmatrix}, & K_3 &= \begin{bmatrix} 12200 \\ 106820 \end{bmatrix}, \\
K_4 &= \begin{bmatrix} 12200 \\ 100480 \end{bmatrix}, & P &= \begin{bmatrix} 442 & 3644 \\ 3644 & 35832 \end{bmatrix}.
\end{aligned}$$

Fig. 4 shows the results without disturbances, i.e. the external force $f_p(t) = 0$, for a stabilization around $\theta = \pi/4$ from the initial position $\theta_0 = \pi/2$. The steady state position is reached in less than $0.3s$. Note that this time response is constrained by the torque limitation to $1000Nm$ due to the motor characteristics. Then, from $t = 0$ to $t = 0.32s$, the input torque Γ_m is saturated to this bound.

To highlight the H_∞ disturbance attenuation the same simulation is presented in fig. 5 but with a sinusoidal disturbance expressed as:

$$f_p(t) = 200 \sin(4\pi t) \quad (19)$$

This sinusoidal disturbance is chosen with a maximum of $200N$ to outperform the force characteristics that can be applied to Multi-ISO's arm by a patient. The time response

is negligently delayed to $0.35s$ and afterward the position reaches its steady state. This shows that the H_∞ control law successfully attenuate the external disturbance by means of a compensation in the input signal Γ_m .

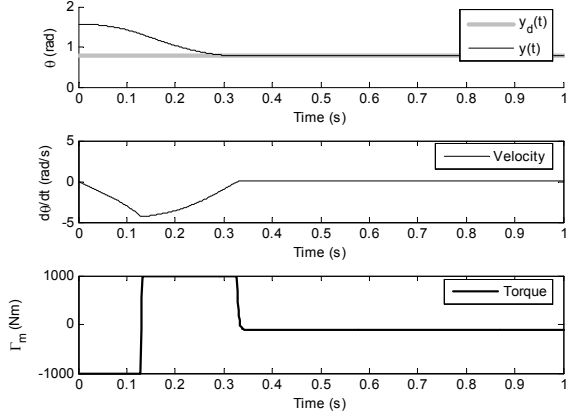

Fig. 4. State and torque simulation for a stabilization without disturbance.

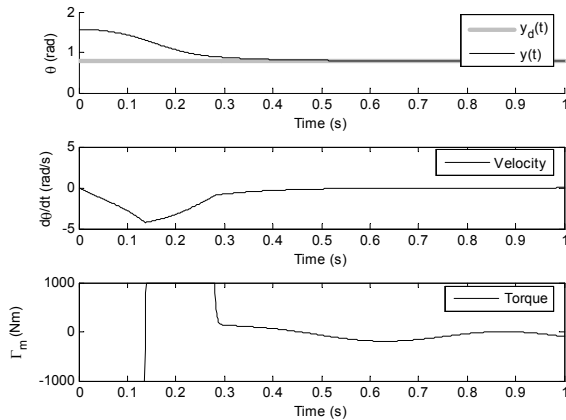

Fig. 5. State and torque simulation for stabilization with sinusoidal disturbance.

Fig. 6 shows the simulation of an isokinetic extension following by an isokinetic flexion trajectory. From $t=0$ to $1s$, the rehabilitation device is in its initial position $\theta_0 = \pi/2rad$. From $t=1s$, the angular position is decreases with a slope of $-\pi/2rad.s^{-1}$ until the position $\theta = \pi/18rad$ is reached. This position is maintained up to $t=3s$. Afterward, angular position increases with a slope of $\pi/2rad.s^{-1}$ until $\theta = \pi/2rad$ is reached and then, the rehabilitation device arm remains immobile. The disturbance (19) is still applied and attenuated by the control law.

Note that, in these simulations, where a trajectory is imposed to the rehabilitation device, the voluntary patient control is not taken into consideration. In the next section we propose a trajectory generator that allows the control of the isokinetic movement by the patient.

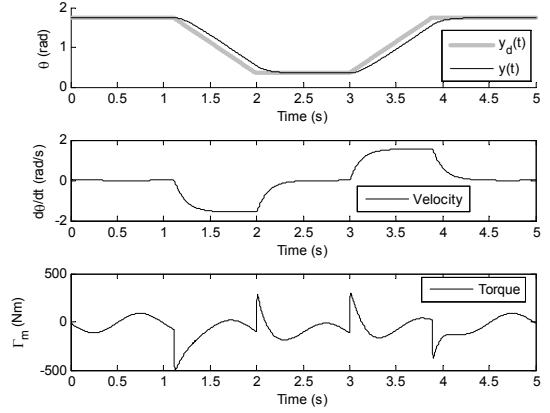

Fig. 6. Simulation following isokinetic trajectories with disturbances

VI. HUMAN CONTROLLED TRAJECTORY GENERATOR

In the previous sections, a PDC control law based on a Takagi-Sugeno Fuzzy modeling was synthesized to ensure the continuous stability of the rehabilitation device. Simulations were proposed but without any control of the patient. In this section, in order to allow the patient to be active with the control of the isokinetic movement, a trajectory generator is proposed where the desired trajectory $y_d(t)$ is computed from the force $f_p(t)$ applied by the patient to the rehabilitation device arm. $f_p(t)$ is then considered both as a disturbance to be attenuated by the Multi-ISO continuous closed-loop system and as an input to impose the required movements, fig. 7.

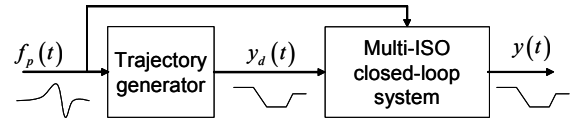

Fig. 7. Human controlled trajectory control scheme.

The trajectory generator has to allow both the eccentric and concentric flexion/extension of the lower limbs. Then the functioning principle can be represented by the state machine given in fig. 8.

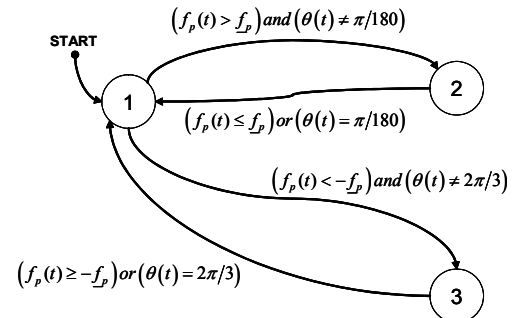

Fig. 8. Trajectory scheduler state machine.

Mode 1 constitutes the initial state where the rehabilitation device should remain immobile in its current position. In mode 2 and 3, the rehabilitation device is required to perform, respectively, an eccentric (extension) isokinetic movement with a slope α_e and a concentric (flexion) isokinetic movement with a slope α_c . These modes are activated if $f_p(t)$ is greater, respectively lower, than a threshold \underline{f}_p and if the bounds of the angular position are not attained.

Fig. 9 shows the simulation results of an extension-flexion lower limb movement. The initial Multi-ISO angular position is $\theta_0 = \pi/2$. Between $t=0$ to $t=1.75s$ the simulated patient applies a positive force to the rehabilitation device (eccentric mode). Starting from $t=1.75s$, the patient applies a negative force to the rehabilitation device (concentric mode). When the force $f_p(t)$ exceeds the threshold \underline{f}_p (that is set here at $\underline{f}_p = 30N$), the isokinetics extension is realized with a slope $\alpha_e = -\pi/3 \text{ rad.s}^{-1}$. When the force $f_p(t)$ goes below the threshold $-\underline{f}_p$, the isokinetics flexion is realized with a slope $\alpha_c = \pi/3 \text{ rad.s}^{-1}$. Note that the parameters α_e , α_c and \underline{f}_p can be set by the clinician to ensure an adapted rehabilitation to each individual.

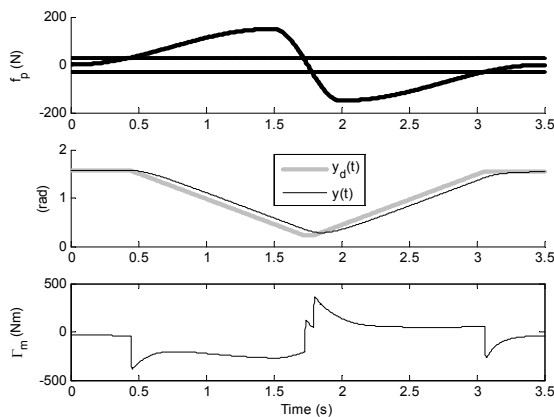

Fig. 9. Simulation of the whole system following the applied patient force to the rehabilitation device.

VII. CONCLUSION

The nonlinear dynamical model of the Multi-ISO rehabilitation device was expressed as a fuzzy Takagi-Sugeno model on a compact of the state space. Based on this modeling, a PDC control law was proposed to stabilize the closed-loop rehabilitation device system. The human force applied to the rehabilitation device's arm was considered as a disturbance to the system dynamics. Then, in a way to

attenuate this disturbance, an H_∞ criterion was considered. Stability conditions were adapted from the ones proposed by [4] for closed-loop disturbed Takagi-Sugeno's models using H_∞ criterion. Some convenient matrix transformations were used to write these conditions as LMI. Then, these conditions have been successfully applied, in simulation, to the Multi-ISO rehabilitation device. The results show that the closed-loop system is able to follow the isokinetic desired trajectories imposed to the patient. In this case, the patient behavior, considered as a sinusoidal disturbance, has been successfully attenuated by the control law. In order to allow the voluntary control of the isokinetic movement by the patient, a human controlled trajectory generator based on a discrete state machine was proposed. This kind of trajectory generator allows the whole systems to be moved only if the patient applies a force that is superior to a force threshold. The later can be tuned by the clinician to ensure an adapted rehabilitation to each individual.

ACKNOWLEDGMENT

The authors would like to thank L. Afilal, S. Moughamir, N. Manamani and G. Lessieur for their technical assistance relating to the Multi-ISO rehabilitation device.

REFERENCES

- [1] S. Moughamir, "Conception et développement d'une machine d'entraînement et de rééducation des membres inférieurs," Ph.D Thesis of University of Reims Champagne Ardenne, 1999.
- [2] S. Moughamir, J. Zaytoon, N. Manamani, and L. Afilal, "A system approach for control development of lower-limbs training machines," *Control Engineering Practice*, vol. 10, 2002, pp. 287–299.
- [3] H. O. Wang, K. Tanaka, M. F. Griffin, "Parallel distributed compensation of nonlinear systems by Takagi-Sugeno Fuzzy Model," *IEEE Transaction on fuzzy systems*, 1995, pp. 531–537.
- [4] W. L. Chiang, T.W. Chen, M.Y. Liu, and C. J. Hsu, "Application and robust control of PDC fuzzy controller for nonlinear systems with external disturbance," *Journal of Marine Science and Technology*, vol. 9, n°2, 2001, pp. 84–90.
- [5] T. Takagi, and M. Sugeno, "Fuzzy identification of systems and its applications to modeling and control," *IEEE trans. Syst. Man. Cybern. Vol. 15*, 1985, pp. 116–132.
- [6] Y. Morère, "Mise en œuvre de lois de commande pour les modèles flous de type Takagi-Sugeno," Ph.D Thesis, University of Valenciennes, France, 2001.
- [7] K. Tanaka, H. O. Wang, "Fuzzy control systems design and analysis. A linear Matrix Inequality Approach," *Wiley-Interscience*, 2001.
- [8] T. M. Guerra, F. Delmotte, L. Vermeiren, H. Tirmant, "Compensation and division control law for fuzzy models," *Fuzzy IEEE*, Melbourne, Australia, 2001.
- [9] S. Boyd, L. El Ghaoui, E. Feron, V. Balakrishnan, "Linear matrix inequality in systems and control theory," 15, *Studies in applied mathematics. SIAM*, Philadelphia, 1994.
- [10] L. El Ghaoui, "LMI approach for control : an introduction.," Control summer school Grenoble, *Robust Identification and Control: LMI approach*, 1997, pp. 1-25.
- [11] P. Gahinet, A. Nemirovski, A. Laub, M. Chilali, "LMI Control Toolbox," *The Mathworks Inc, Natick*, MA, 1995.
- [12] R. Nikoukhah, F. Delbecq, L. El Ghaoui, "LMI tool: a package for LMI optimisation in scilab," <http://www-rocq.inria.fr/scilab/>, 1995.
- [13] P. De Larminat, *Automatique, commande des systèmes linéaires (Book Style). Hermes*, Paris, 1993, pp. 163-172.